

DKL koncovka s univerzálnym
 kuželom 24° až 60° - podľa DIN 3868
 priama 0°

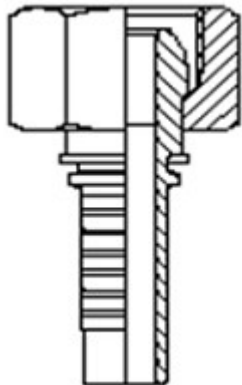
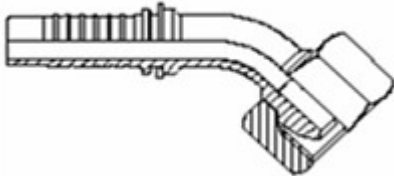
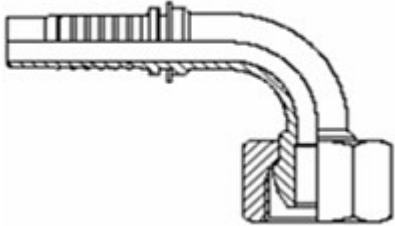

DN	závit / thread
06	DKL 06 12x1,5
06	DKL 06 14x1,5
06	DKL 06 16x1,5
08	DKL 08 16x1,5
08	DKL 08 18x1,5
08	DKL 08 20x1,5
10	DKL 10 16x1,5
10	DKL 10 18x1,5
10	DKL 10 20x1,5
10	DKL 10 22x1,5
12	DKL 12 22x1,5
12	DKL 12 20x1,5AC
16	DKL 16 26x1,5
16	DKL 16 27x1,5
16	DKL 16 27x1,5AC
16	DKL 16 27x 2
20	DKL 20 30x1,5
20	DKL 20 30x 2
20	DKL 20 33x 1,5AC
20	DKL 20 33x 2 AC
25	DKL 25 36x 2
25	DKL 25 39x1,5
32	DKL 32 45x1,5
32	DKL 32 45x2

<p>DKL koncovka s univerzálnym kuželom 24° až 60° - podľa DIN 3868 uhlová 45°</p> 	DN	závit / thread
	06	DKL 06 14x1,5/45
	06	DKL 06 16x1,5/45
	08	DKL 08 16x1,5/45
	10	DKL 10 18x1,5/45
	10	DKL 10 20x1,5/45
	10	DKL 10 22x1,5/45
	12	DKL 12 22x1,5/45
	16	DKL 16 26x1,5/45
	16	DKL 16 27x1,5/45
	16	DKL 16 27x 2/45

<p>DKL koncovka s univerzálnym kuželom 24° až 60° - podľa DIN 3868 uhlová 90°</p> 	DN	závit / thread
	06	DKL 06 14x1,5/90
	06	DKL 06 16x1,5/90
	08	DKL 08 16x1,5/90
	08	DKL 08 18x1,5/90
	10	DKL 10 16x1,5/90
	10	DKL 10 18x1,5/90
	10	DKL 10 20x1,5/90
	10	DKL 10 22x1,5/90
	12	DKL 12 22x1,5/90
	16	DKL 16 26x1,5/90
16	DKL 16 27x1,5/90	
16	DKL 16 27x 2/90	

DKOL koncovka s O-krúžkom
 kuželom 24° - podľa DIN 3865
 priama 0°

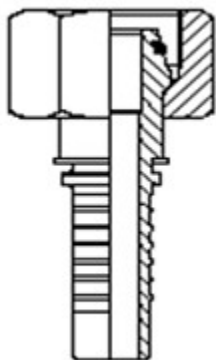

DN	závit / thread
05	DKOL 05 12x1,5
06	DKOL 06 12x1,5
06	DKOL 06 14x1,5
06	DKOL 06 16x1,5
06	DKOL 06 18x1,5
08	DKOL 08 14x1,5
08	DKOL 08 16x1,5
08	DKOL 08 18x1,5
08	DKOL 08 20x1,5
10	DKOL 10 16x1,5
10	DKOL 10 18x1,5
10	DKOL 10 20x1,5
10	DKOL 10 22x1,5
13	DKOL 12 18x1,5
12	DKOL 12 22x1,5
12	DKOL 12 26x1,5
16	DKOL 16 22x1,5
16	DKOL 16 26x1,5
16	DKOL 16 27x1,5
16	DKOL 16 27x 2
16	DKOL 16 30x 2
20	DKOL 20 26x1,5
20	DKOL 20 30x1,5
20	DKOL 20 30x 2
25	DKOL 25 36x 2
32	DKOL 32 45x 2
40	DKOL 40 52x 2

DKOL koncovka s O-krúžkom
 kuželom 24° - podľa DIN 3865
 priama 45°

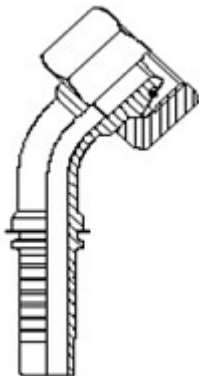

DN	závit / thread
05	DKOL 05 12x1,5/45
06	DKOL 06 12x1,5/45
06	DKOL 06 14x1,5/45
06	DKOL 06 16x1,5/45
06	DKOL 06 18x1,5/45
08	DKOL 08 16x1,5/45
08	DKOL 08 18x1,5/45
10	DKOL 10 16x1,5/45
10	DKOL 10 18x1,5/45
10	DKOL 10 22x1,5/45
12	DKOL 12 26x1,5/45
12	DKOL 12 22x1,5/45
16	DKOL 16 26x1,5/45
16	DKOL 16 27x1,5/45
16	DKOL 16 27x 2 /45
20	DKOL 20 26x1,5/45
20	DKOL 20 30x1,5/45
20	DKOL 20 30x 2 /45
25	DKOL 25 36x 2 /45
32	DKOL 32 45x 2 /45
40	DKOL 40 52x 2 /45

DKOL koncovka s O-krúžkom
 kuželom 24° - podľa DIN 3865
 priama 90°

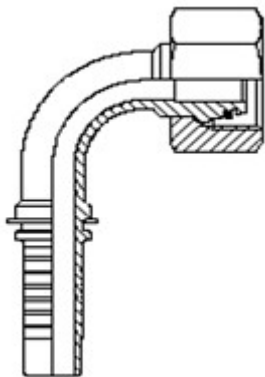

DN	závit / thread
05	DKOL 05 12x1,5/90
06	DKOL 06 12x1,5/90
06	DKOL 06 14x1,5/90
06	DKOL 06 16x1,5/90
06	DKOL 06 18x1,5/90
08	DKOL 08 14x1,5/90
08	DKOL 08 16x1,5/90
08	DKOL 08 18x1,5/90
10	DKOL 10 16x1,5/90
10	DKOL 10 18x1,5/90
10	DKOL 10 22x1,5/90
12	DKOL 12 18x1,5/90
12	DKOL 12 22x1,5/90
12	DKOL 12 26x1,5/90
16	DKOL 16 22x1,5/90
16	DKOL 16 26x1,5/90
16	DKOL 16 27x1,5/90
16	DKOL 16 27x 2/90
16	DKOL 16 30x 2/90
20	DKOL 20 26x1,5/90
20	DKOL 20 30x1,5/90
20	DKOL 20 30x 2 /90
20	DKOL 20 36x 2 /90
25	DKOL 25 36x 2 /90
32	DKOL 32 45x 2 /90
40	DKOL 40 52x 2 /90

DKOS koncovka s O-krúžkom
 kuželom 24° - podľa DIN 3865
 priama 0° - ťažká rada

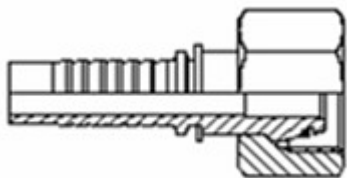

DN	závit / thread
06	DKOS 06 14x1,5
06	DKOS 06 16x1,5
06	DKOS 06 18x1,5
06	DKOS 08 16x1,5
08	DKOS 08 18x1,5
08	DKOS 08 20x1,5
10	DKOS 10 18x1,5
10	DKOS 10 20x1,5
10	DKOS 10 22x1,5
12	DKOS 12 22x1,5
12	DKOS 12 24x1,5
12	DKOS 13 30x 2
16	DKOS 16 24x1,5
16	DKOS 16 30x 2
20	DKOS 20 30x 2
20	DKOS 20 36x 2
25	DKOS 25 36x 2
25	DKOS 25 42x 2
32	DKOS 25 52x 2
32	DKOS 32 52x 2
38	DKOS 38 52x 2

DKOS koncovka s O-krúžkom
 kuželom 24° - podľa DIN 3865
 priama 45° - ťažká rada

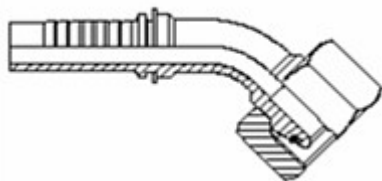

DN	závit / thread
06	DKOS 06 14x1,5/45
06	DKOS 06 16x1,5/45
06	DKOS 06 18x1,5/45
06	DKOS 06 20x1,5/45
08	DKOS 08 18x1,5/45
08	DKOS 08 20x1,5/45
10	DKOS 10 18x1,5/45
10	DKOS 10 20x1,5/45
10	DKOS 10 22x1,5/45
12	DKOS 12 22x1,5/45
12	DKOS 12 24x1,5/45
16	DKOS 16 30x 2/45
20	DKOS 20 30x 2/45
20	DKOS 20 36x 2/45
25	DKOS 25 36x 2/45
25	DKOS 25 42x 2/45
32	DKOS 32 52x 2/45
40	DKOS 38 52x 2/45

DKOS koncovka s O-krúžkom
 kuželom 24° - podľa DIN 3865
 priama 90° - ťažká rada

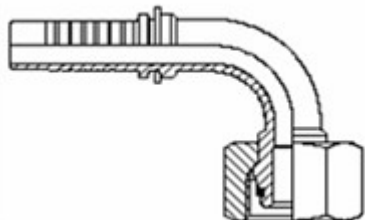

DN	závit / thread
06	DKOS 06 14x1,5/90
06	DKOS 06 16x1,5/90
06	DKOS 06 18x1,5/90
06	DKOS 06 20x1,5/90
08	DKOS 08 18x1,5/90
08	DKOS 08 20x1,5/90
10	DKOS 10 18x1,5/90
10	DKOS 10 20x1,5/90
10	DKOS 10 22x1,5/90
10	DKOS 12 22x1,5/90
12	DKOS 12 24x1,5/90
16	DKOS 16 30x 2/90
20	DKOS 20 30x 2/90
20	DKOS 20 36x 2/90
25	DKOS 25 36x 2/90
25	DKOS 25 42x 2/90
32	DKOS 32 52x 2/90
40	DKOS 38 52x 2/90

CES von. závit 24° kužel
 ťažká rada DIN 3853

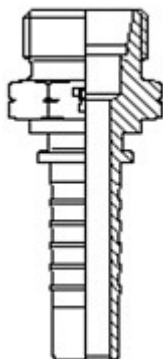

DN	závit / thread
06	CES 06 14x1,5
06	CES 06 16x1,5
06	CES 06 18x1,5
06	CES 06 20x1,5
08	CES 08 18x1,5
08	CES 08 20x1,5
10	CES 10 18x1,5
10	CES 10 20x1,5
10	CES 10 22x1,5
12	CES 12 22x1,5
12	CES 12 24x1,5
16	CES 16 30x 2
20	CES 20 30x 2
20	CES 20 36x 2
25	CES 25 36x 2
25	CES 25 42x 2
32	CES 32 42x2
32	CES 32 52x2
38	CES 38 52x2

CES von. závit 24° kužel
 ľahká rada DIN 3853

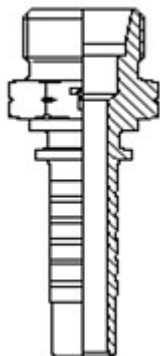

DN	závit / thread
05	CEL 05 12X1,5
06	CEL 06 12X1,5
06	CEL 06 14X1,5
06	CEL 06 16X1,5
06	CEL06 M18x1,5
08	CEL 08 14x1,5
08	CEL 08 16X1,5
08	CEL 08 18X1,5
10	CEL 10 16X1,5
10	CEL 10 18X1,5
10	CEL 10 22x1,5
13	CEL 13 18x1,5
13	CEL 13 22x1,5
13	CEL 13 26x1,5
16	CEL 16 26x1,5
16	CEL 16 27x 2
16	CEL 16 30x 2
20	CEL 20 26x 1,5
20	CEL 20 30x 2
25	CEL 25 36x 2
32	CEL 32 45x 2
40	CEL 40 52x 2

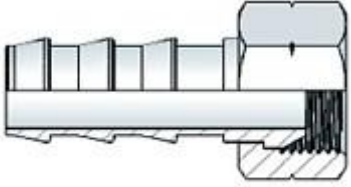
NT DKL M 	DN	závit / thread
	04	Nt 04 12x1,5
	06	Nt 06 14x1,5
	08	Nt 08 16x1,5
	10	Nt 10 18x1,5
	13	Nt 13 22x1,5
	16	t16 27x1,5
	32	Nt 32 45x1,5
	32	Nt 32 45x2

M+N nízkotlak rovné čelo vzduch	DN	závit / thread
	13	Nt13R.Č. 22x1,5

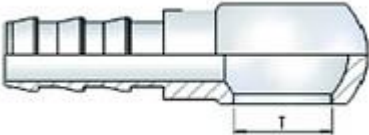
NT banjo 	DN	závit / thread
	06	Nt oko 6D12
	08	Nt oko 8D12
	08	Nt oko 8D14

Fúkacia koncovka	04	ventil fúkací 04
	04	šrobenie fukanie 04

DKR koncovka s kuželom 60°
 uhlová 0° BSP závit

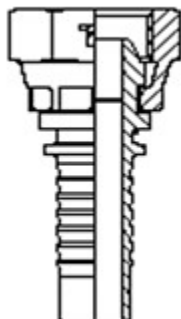

DN	závit / thread
05	DKR 5 G 1/8" -28
05	DKR 5 G 1/4" -28
06	DKR 6 G 1/8" -28
06	DKR 6 G 1/4" -19
06	DKR 6 G 3/8" -19
06	DKR 6 G 1/2" -14
08	DKR 8 G 1/4" -19
08	DKR 8 G 3/8" -19
08	DKR 8 G 1/2" -14
10	DKR10 G 1/4" -19
10	DKR10 G 3/8" -19
10	DKR10 G 1/2" -14
12	DKR12 G 3/8" -19
12	DKR12 G 1/2" -14
12	DKR12 G 5/8" -14
12	DKR12 G 3/4" -14
16	DKR16 G 1/2" -14
16	DKR16 G 5/8" -14
16	DKR16 G 3/4" -14
20	DKR20 G 5/8" -14
20	DKR20 G 3/4" -14
20	DKR20 G 1" -11
25	DKR25 G 3/4" -14
25	DKR25 G 1" -11
25	DKR25 G1 1/4" -11
32	DKR32 G 1" 1/4 -11
32	DKR32 G1 1/2 -11
40	DKR40 G1 1/2" -11
40	DKR40 G 2" -11
50	DKR50 G 2" -11

DKR koncovka s kuželom 60°
 uhlová 90° BSP závit

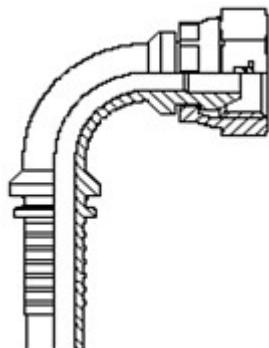

DN	závit / thread
05	DKR 5 G 1/8"-28/90
06	DKR 6 G 1/8"-28/90
06	DKR 6 G 1/4"-19/90
06	DKR 6 G 3/8"-19/90
06	DKR 6 G 1/2"-14/90
08	DKR 8 G 1/4"-19/90
08	DKR 8 G 3/8"-19/90
08	DKR 8 G 1/2"-14/90
10	DKR10 G 1/4" -14/90
10	DKR10 G 3/8" -19/90
10	DKR10 G 1/2" -14/90
12	DKR12 G 3/8" -19/90
12	DKR12 G 1/2" -14/90
12	DKR12 G 5/8"-14/90
12	DKR12 G 3/4"-14/90
16	DKR16 G 1/2 -14/90
16	DKR16 G 5/8 -14/90
16	DKR16 G 3/4"-14/90
20	DKR20 G 1/2"-14/90
20	DKR20 G 5/8"-14/90
20	DKR20 G 3/4"-14/90
20	DKR20 G 1" -11/90
25	DKR25 G 3/4" -14/90
25	DKR25 G 1" -11/90
25	DKR25 G 1 1/4"-11/90
32	DKR32 G 1 1/4"-11/90
32	DKR32 G 1 1/2"-11/90
40	DKR40 G 1 1/2"-11/90
40	DKR40 G 2"-11/90
50	DKR50 G 2" -11/90

DKR koncovka s kuželom 60°
 uhlová 45° BSP závit

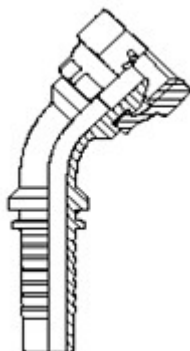

DN	závit / thread
06	DKR 6 G1/8"-28/45
06	DKR 6 G1/4" -19/45
06	DKR 6 G3/8"-19/45
06	DKR 6 G1/2"-14/45
08	DKR 8 G1/4" -19/45
08	DKR 8 G3/8" -19/45
08	DKR 8 G1/2" -14/45
10	DKR10 G1/4"-19/45
10	DKR10 G3/8"-19/45
10	DKR10 G1/2" -14/45
12	DKR12 G3/8" -19/45
12	DKR12 G1/2" -14/45
12	DKR12 G5/8" -14/45
12	DKR12 G3/4" -14/45
16	DKR16 G1/2" -14/45
16	DKR16 G3/4" -14/45
16	DKR16 G5/8" -14/45
20	DKR20 G1/2" -14/45
20	DKR20 G5/8" -14/45
20	DKR20 G3/4" -14/45
20	DKR20 G 1" -11/45
25	KR25 G 3/4" -14/45
25	DKR25 G 1" -11/45
25	KR25 G1 1/4" -11/45
32	KR32 G1 1/4" -11/45
32	KR32 G1 1/2" -11/45
40	KR40 G1 1/2" -11/45
40	DKR40 G2" -11/45
50	DKR50 G 2" -11/45

AGR koncovky vnútorný 60° kužel

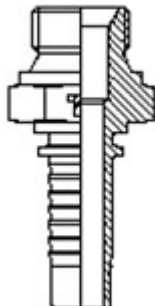

DN	závit / thread
05	AGR 5 G1/8" -26
05	AGR 5 G1/4" -27
06	AGR 6 G1/8" -28
06	AGR 6 G1/4" -19
06	AGR 6 G3/8" -19
06	AGR 6 G1/2" -14
08	AGR 8 G1/4" -19
08	AGR 8 G3/8" -19
08	AGR 08 G1/2-14
10	GR10 G3/8" -19
10	GR10 G1/2" -14
10	AGR10 G1/4-14
12	GR12 G3/8" -19
12	GR12 G1/2" -14
12	GR12 G5/8" -14
12	GR12 G3/4" -14
16	GR16 G1/2" -14
16	GR16 G5/8" -14
16	GR16 G3/4" -14
20	GR20 G 1/2" -14
20	AGR20 G3/4 -14
20	AGR20 G 1" -11
25	GR25 G3/4" -14
25	AGR25 G 1" -11
25	GR25 G1 1/4" -11
32	GR32 G1 1/4" -11
32	GR32 G1 1/2" -11
40	GR40 G1 1/2" -12
40	AGR40 G2" -12
50	AGR50 G 2 -11

AGR-K koncovky AGR s kuželovým zavítom

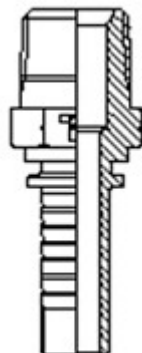

DN	závit / thread
06	AGR-K 6 G1/8" -27
06	AGR-K 6 G1/4" -18
06	AGR-K 6 G3/8" -19
08	AGR-K 8 G1/4" -18
08	AGR-K 8 G3/8" -18
08	AGR-K 08 G1/2-14
10	AGR-K10 G1/4-14
10	AGR-K10 G3/8" -18
10	AGR-K10 G1/2" -14
12	AGR-K12 G3/8" -18
12	AGR-K12 G1/2" -14
12	AGR-K12 G5/8" -14
12	AGR-K12 G3/4" -14
16	AGR-K16 G1/2" -14
16	AGR-K16 G5/8" -14
16	AGR-K16 G3/4" -14
20	AGR-K20 G3/4 -14
20	AGR-K20 G 1" -11
25	AGR-K25 G 1" -11
25	AGR-K25 G1 1/4" -11
32	AGR-K32 G1 1/4" -11
32	AGR-K32 G1 1/2" -11
40	AGR-K40 G1 1/2" -11
40	AGR-K40 G2" -12
50	AGR-K50 G 2 -11

AGN koncovky NPT vnútorný 60° kužel

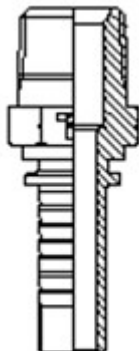

DN	závit / thread
06	AGN 6 G1/8" -27
06	AGN 6 G1/4" -18
06	AGN 6 G3/8" -19
08	AGN 8 G1/4" -18
08	AGN 8 G3/8" -18
08	AGN 08 G1/2-14
10	AGN10 G1/4-14
10	AGN10 G3/8" -18
10	AGN10 G1/2" -14
12	AGN12 G3/8" -18
12	AGN12 G1/2" -14
12	AGR12 G5/8" -14
12	AGN12 G3/4" -14
16	AGN16 G1/2" -14
16	AGR16 G5/8" -14
16	AGN16 G3/4" -14
20	AGR20 G 1/2" -14
20	AGN20 G3/4 -14
20	AGN20 G 1" -11
25	AGN25 G 1" -11
25	AGN25 G1 1/4" -11
32	AGN32 G1 1/4" -11
32	AGR32 G1 1/2" -11
40	AGN40 G1 1/2" -11
40	AGR40 G2" -12
50	AGN50 G 2 -11

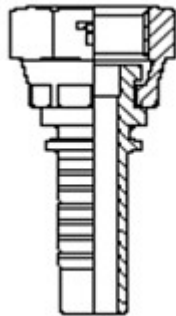
DKR-F koncovka BSP tesnenie na plochu(rovnné čelo)	DN	závit / thread
		06
06		DKR-F 06 G3/8"
08		DKR-F 08 G1/4"
08		DKR-F 08 G3/8"
08		DKR-F 08 G1/2"
10		DKR-F 10 G3/8"
10		DKR-F 10 G1/2"
12		DKR-F 12 G1/2"
12		DKR-F 12 G5/8"
12		DKR-F 12 G3/4"
16		DKR-F 16 G5/8"
16		DKR-F 16 G3/4"
20		DKR-F 20 G3/4"
20		DKR-F 20 G 1"
25		DKR-F 25 G 1"

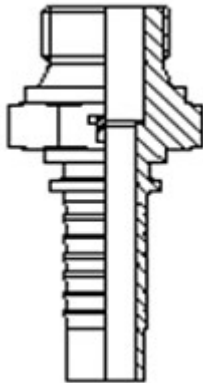
AGR-F koncovka BSP tesnenie na plochu(rovnné čelo)	DN	závit / thread
		06
06		AGR-F 06 G3/8"
08		AGR-F 08 G3/8"
10		AGR-F 10 G3/8"
10		AGR-F 10 G1/2"
12		AGR-F 12 G1/2"
12		AGR-F 12 G5/8"
12		AGR-F 12 G3/4"
16		AGR-F 16 G5/8"
16		AGR-F 16 G3/4"
20		AGR-F 20 G3/4"
20		AGR r.č.20 G1"
25		AGR-F 25 G 1"

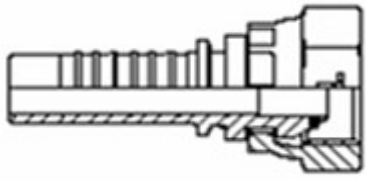
DKOR koncovka s kuželom 60° 	DN	závit / thread
	06	DKOR 6 G1/4" -19
	10	DKOR10 G3/8" -19
	12	DKRO12 G1/2" -14
	16	DKOR16 G5/8" -14
	20	DKOR20 G3/4" -14
	25	DKOR25 G 1" -11

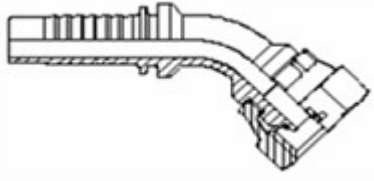
DKOR 45° BSP závit 	DN	závit / thread
	06	DKOR 6 G1/4" -19/45
	10	DKOR10 G3/8" -19/45
	12	DKOR12 G1/2" -14/45
	16	DKOR16 G5/8" -14/45
	20	DKOR20 G3/4" -14/45
	25	DKOR25 G 1" -14/45

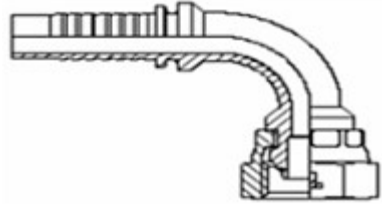
DKOR 90° BSP závit 	DN	závit / thread
	06	DKOR 6 G1/4" -19/90
	10	DKOR10 G3/8" -19/90
	12	DKOR12 G1/2" -14/90
	16	DKOR16 G5/8" -14/90
	20	DKOR20 G3/4" -14/90
	25	DKOR25 G 1" -11/90

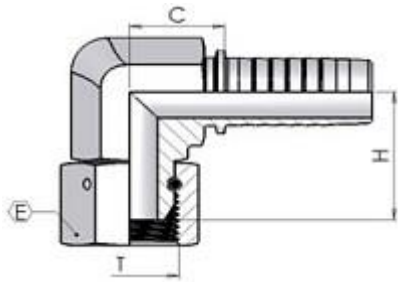
DKR 90° COMPACT 	DN	závit / thread
	06	DKR-K 6 G1/4"-14/90
	08	DKR-K 8 G3/8"-19/90
	10	DKR-K 10 G3/8"-19/90
	12	DKR-K 12 G1/2"-14/90
	16	DKR-K 16 G5/8"-14/90
	20	DKR-K 20 G3/4"-14/90
	25	DKR-K 25 G1"-1/90

DKJ koncovka 74° kužel
 UNF vnútorný závit JIC norma
 priama 0°

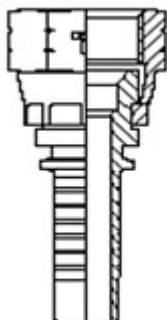

DN	závit / thread
06	DKJ6 7/16"-20
06	DKJ6 1/2"-20
06	DKJ6 9/16"-18
08	DKJ8 1/2"-20
08	DKJ8 9/16"-18
08	DKJ8 3/4"-16
10	DKJ10 7/16"-20
10	DKJ10 1/2"-20
10	DKJ10 9/16"-18
10	DKJ10 3/4"-16
10	DKJ10 7/8"-14
12	DKJ12 9/16"-18
12	DKJ12 3/4"-16
12	DKJ12 7/8"-14
12	DKJ12 1.1/16"-12
16	DKJ16 3/4"-13
16	DKJ16 7/8"-14
16	DKJ16 1.1/16"-12
20	DKJ20 3/4"-16
20	DKJ20 7/8"-14
20	DKJ20 1.1/16"-12
20	DKJ20 1.3/16"-12
20	DKJ20 1.5/16"-12
25	DKJ25 1.1/16"-12
25	DKJ25 1.5/16"-12
25	DKJ25 1.5/8"-12
32	DKJ32 1.5/8"-12
32	DKJ32 1.7/8"-12
40	DKJ40 1.7/8"-12
50	DKJ50 2 1/2"-12

DKJ koncovka 74° kužel
 UNF vnútorný závit JIC norma
 uhlová 45°

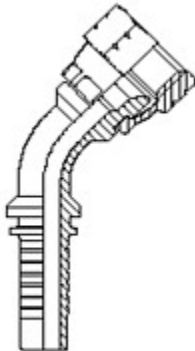

DN	závit / thread
06	DKJ6 7/16"-20/45
06	DKJ6 1/2"-20/45
06	DKJ6 9/16"-18/45
08	DKJ8 1/2"-20/45
08	DKJ8 9/16"-18/45
08	DKJ8 3/4"-16/45
10	DKJ10 9/16"-18/45
10	DKJ10 3/4"-16/45
10	DKJ10 7/8"-14/45
12	DKJ12 3/4"-16/45
12	DKJ12 7/8"-14/45
12	DKJ12 1.1/16"-12/45
16	DKJ16 7/8"-14/45
16	DKJ16 1.1/16"-12/45
20	DKJ20 7/8"-14/45
20	DKJ20 1.1/16"-12/45
20	DKJ20 1.3/16"-12/45
20	DKJ20 1.5/16"-12/45
25	DKJ25 1.1/16"-12/45
25	DKJ25 1.5/16"-12/45
25	DKJ25 1.5/8"-12/45
32	DKJ32 1.5/8"-12 /45
32	DKJ32 1.7/8"-12 /45
40	DKJ40 1.7/8"-12 /45
50	DKJ50 2 1/2"-12 /45

DKJ koncovka 74° kužel
 UNF vnútorný závit JIC norma
 priama 90°

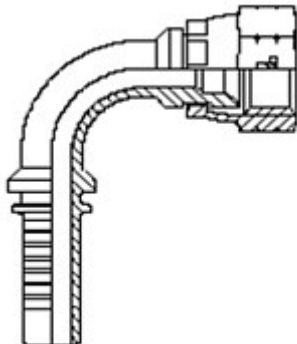

DN	závit / thread
06	DKJ6 7/16"-20/90
06	DKJ6 1/2"-20/90
06	DKJ6 9/16"-18/90
08	DKJ8 1/2"-20/90
08	DKJ8 9/16"-18/90
08	DKJ8 3/4"-16/90
10	DKJ10 9/16"-18/90
10	DKJ10 3/4"-16/90
10	DKJ10 7/8"-14/90
12	DKJ12 9/16"-18/90
12	DKJ12 3/4"-16/90
12	DKJ12 7/8"-14/90
12	DKJ12 1.1/16"-12/90
16	DKJ16 7/8"-14/90
16	DKJ16 1.1/16"-12/90
20	DKJ20 7/8"-14/90
20	DKJ20 1.1/16"-12/90
20	DKJ20 1.3/16"-12/90
20	DKJ20 1.5/16"-12/90
25	DKJ25 1.1/16"-12/90
25	DKJ25 1.5/16"-12/90
25	DKJ25 1.5/8"-12/90
32	DKJ32 1.5/8"-12/90
32	DKJ32 1.7/8"-12/90
40	DKJ40 1.7/8"-12/90
50	DKJ50 2 1/2"-12/90

AGJ koncovky vonkajší 74° kužel
 UNF vonkajší závit (JIC norma)
 priama 0°

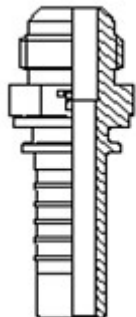

DN	závit / thread
06	AGJ6 7/16"-20
06	AGJ6 1/2"-20
06	AGJ6 9/16"-18
08	AGJ8 1/2"-20
08	AGJ8 9/16"-18
08	AGJ8 3/4"-16
10	AGJ10 9/16"-18
10	AGJ10 3/4"-16
10	AGJ10 7/8"-14
12	AGJ12 9/16"-18
12	AGJ12 3/4"-16
12	AGJ12 7/8"-14
12	AGJ12 1.1/16"-12
16	AGJ16 7/8"-14
16	AGJ16 1.1/16"-12
20	AGJ20 7/8"-14
20	AGJ20 1.1/16"-12
20	AGJ20 1.3/16"-12
20	AGJ20 1.5/16"-12
25	AGJ25 1.1/16"-12
25	AGJ25 1.5/16"-12
25	AGJ25 1.5/8"-12
32	AGJ32 1.5/8"-12
32	AGJ32 1.7/8"-12
40	AGJ38 1.7/8"-12
50	AGJ50 2 1/2"-12

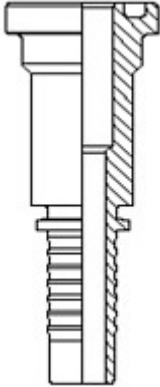
SFL 0° 3000 PSI priama 0° JEDEN KUS		DN	závit / thread
		12	SFL12 1/2"
		12	SFL12 3/4"
		16	SFL16 3/4"
		20	SFL20 1/2"
		20	SFL20 3/4"
		20	SFL20 1"
		25	SFL25 3/4"
		25	SFL25 1"
		25	SFL25 1 1/4"
		32	SFL32 1"
		32	SFL32 1 1/4"
		32	SFL32 1 1/2"
		40	SFL40 1 1/2"
		40	SFL40 2"
50	SFL50 2"		

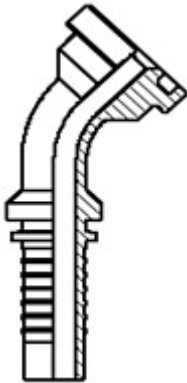
SFL 3000 PSI uhlová 45° JEDEN KUS		DN	závit / thread
		12	SFL12-45 1/2"
		12	SFL12-45 3/4"
		16	SFL16-45 3/4"
		20	SFL20-45 3/4"
		20	SFL20-45 1"
		25	SFL25-45 1"
		25	SFL25-45 1 1/4"
		32	SFL32-45 1 1/4"
		32	SFL32-45 1 1/2"
		40	SFL40-45 1 1/2"
		40	SFL40-45 2"
		50	SFL50-45 2"

SFL 3000 PSI
 uhlová 90° JEDEN KUS

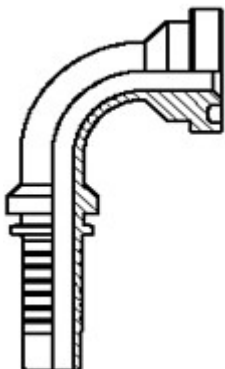

DN	závit / thread
12	SFL12-90 1/2"
12	SFL12-90 3/4"
16	SFL16-90 3/4"
20	SFL20-90 1/2"
20	SFL20-90 3/4"
20	SFL20-90 1"
25	SFL25-90 3/4"
25	SFL25-90 1"
25	SFL25-90 1 1/4"
32	SFL32-90 1 "
32	SFL32-90 1 1/4"
32	SFL32-90 1 1/2"
40	SFL40-90 1 1/2"
40	SFL40-90 2"
50	SFL50-90 2"

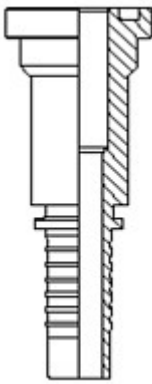
SFS 0° 6000 PSI priama 0°		DN	závit / thread
		12	SFS12 1/2"
		12	SFS12 3/4"
		16	SFS16 1/2"
		16	SFS16 3/4"
		20	SFS16 1"
		20	SFS20 3/4"
		20	SFS20 1"
		25	SFS25 3/4"
		25	SFS25 1"
		25	SFS25 1 1/4"
		32	SFS32 1 "
		32	SFS32 1 1/4"
		32	SFS32 1 1/2"
		40	SFS40 1 1/2"
		40	SFS40 2"
		50	SFS50 2"

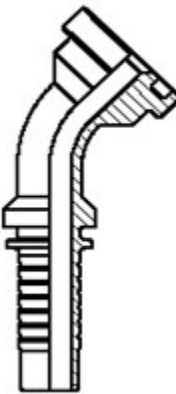
SFS 6000 PSI uhlová 45°		DN	závit / thread
		12	SFS12-45 1/2"/45
		12	SFS12-45 1/4"/45
		16	SFS16-45 1/2"/45
		16	SFS16-45 3/4"/45
		20	SFS20-45 1/2"/45
		20	SFS20-45 3/4"/45
		20	SFS20-45 1"/45
		25	SFS25-45 3/4"/45
		25	SFS25-45 1"/45
		25	SFS25-45 1 1/4"/45
		32	SFS32-45 1 "/45
		32	SFS32-45 1 1/4"/45
		32	SFS32-45 1 1/2"/45
		40	SFS40-45 1 1/2"/45
		40	SFS40-45 2"/45
		50	SFS50-45 2"/45

SFS 6000 PSI
 uhlová 90°

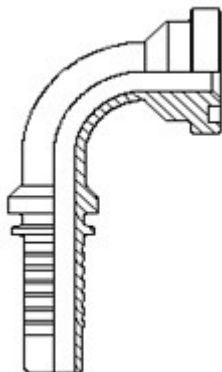

DN	závit / thread
12	SFS12-90 1/2"/90
12	SFS12-90 3/4"/90
16	SFS16-90 3/4"/90
16	SFS16-90 1"/90
20	SFS20-90 1/2"/90
20	SFS20-90 3/4"/90
20	SFS20-90 1"/90
25	SFS25-90 3/4"/90
25	SFS25-90 1"/90
25	SFS25-90 1 1/4"/90
32	SFS32-90 1 "/90
32	SFS32-90 1 1/4"/90
32	SFS32-90 1 1/2"/90
40	SFS40-90 1 1/2"/90
40	SFS40-90 2"/90
50	SFS50-90 2"/90

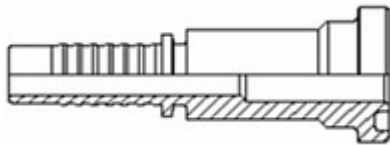
SFS CAT 0° 6000 PSI priama 0° JEDEN KUS 	DN	závit / thread
	20	SFS20 3/4"
	20	SFS20 1"
	25	SFS25 1"
	25	SFS25 1 1/4"
	32	SFS32 1 1/4"
	32	SFS32 1 1/2"
	40	SFS40 1 1/2"

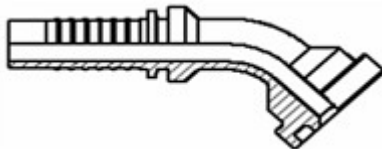
SFS CAT 45° 6000 PSI uhlová 45° 	DN	závit / thread
	20	SFS20-45 3/4"
	20	SFS20-45 1"
	25	SFS25-45 1"
	25	SFS25-45 1 1/4"
	32	SFS32-45 1 1/4"
	32	SFS32-45 1 1/2"
	40	SFS40-45 1 1/2"

SFS CAT 90° 6000 PSI uhlová 90° 	DN	závit / thread
	20	SFS20-90 3/4"
	20	SFS20-90 1"
	25	SFS25-90 1"
	25	SFS25-90 1 1/4"
	32	SFS32-90 1 1/4"
	32	SFS32-90 1 1/2"
	40	SFS45-90 1 1/2"

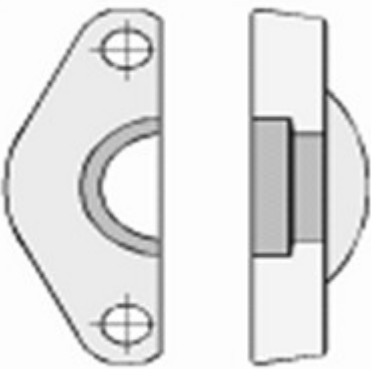
príruby k SFL prírubam		DN	závit / thread
 <p>1 ks obsahuje 2x polmesiac</p>		12	polmesiac SFL12
		20	polmesiac SFL20
		25	polmesiac SFL25
		32	polmesiac SFL32
		40	polmesiac SFL40
		50	polmesiac SFL50

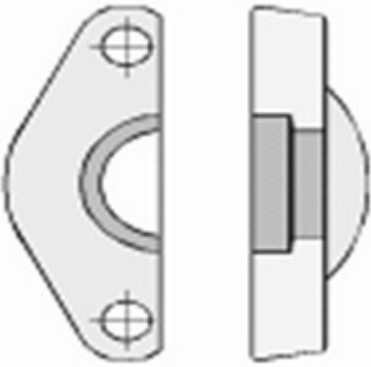
príruby k SFS prírubam		DN	závit / thread
 <p>1 ks obsahuje 2x polmesiac</p>		12	polmesiac SFS12
		20	polmesiac SFS20
		25	polmesiac SFS25
		32	polmesiac SFS32
		40	polmesiac SFS40
		50	polmesiac SFS50

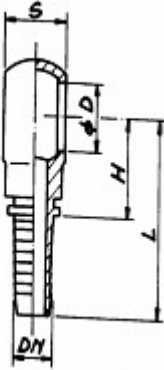
BANJO metric	DN	závit / thread
	06	banjo 6/D10
	06	banjo 6/D14
	06	banjo 6/D12
	08	banjo 8/D12
	08	banjo 8/D14
	08	banjo 8/D16
	08	banjo 8/D18
	10	banjo 10/D14
	10	banjo 10/D16
	10	banjo 10/D18
	10	banjo 10/D20
	10	banjo 10/D22
	12	banjo 12/D18
	12	banjo 12 /D20
	12	banjo 12/D22
	12	banjo 12 /D26
	16	banjo 16/D22
	16	banjo 16/D26
	20	banjo 19/D26
	20	banjo 19/D30
25	banjo 25/D30	

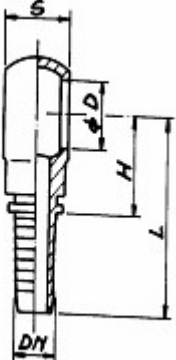
BSP		DN	závit / thread
		06	banjo 6/D1/4"
06	banjo 6/D3/8"		
06	banjo 6/D1/2"		
08	banjo 8/D1/4"		
08	banjo 8/D3/8"		
10	banjo 10/D1/4"		
10	banjo 10/D3/8"		
10	banjo 10/D1/2"		
12	banjo 12/D3/8"		
12	banjo 12/D1/2"		
12	banjo 12/D5/8"		
12	banjo 12/D3/4"		
16	banjo 16/D5/8"		
16	banjo 16/D3/4"		
20	banjo 19/D3/4"		
20	banjo 19/D1"		
25	banjo 25/D1"		

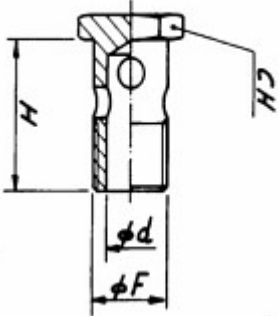
prietokový šrób		F	
		metrická prietoková skrutka	
M10x1	080810-10		
M12x1,5	080810-12		
M14x1,5	080810-14		
M16x1,5	080810-16		
M18x1,5	080810-18		
M20x1,5	080810-20		
M22x1,5	080810-22		
M26x1,5	080810-26		
BSP prietoková skrutka			
G 1/8"	080210-02		
G 1/4"	080210-04		
G 3/8"	080210-06		
G 1/2"	080210-08		
G 5/8"	080210-10		
G 3/4"	080210-12		
G 1"	080210-16		

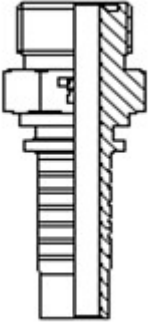
<p>ORFS-AK koncovka tesnenie na plochu Caterpillar, Fiat</p> 	DN	závit / thread
	06	AK 06 9/16"-18
	06	AK 06 11/16"-16
	08	AK 08 11/16"-16
	10	AK 10 11/16"-16
	10	AK 10 13/16"-16
	10	AK 10 1-14"-17
	13	AK 13 13/16"-16
	13	AK 13 1"-14
	13	AK 13 1.3/16"-12
	16	AK 16 1"-14
	16	AK 16 1.3/16"-12
	20	AK 20 1.3/16"-12
	20	AK 20 1.7/16"-12
	25	AK 25 1.7/16"-12
25	AK 25 1.11/16"-12	
32	AK 32 1.11/16"-12	

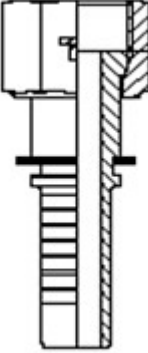
<p>ORFS-DK koncovka tesnenie na plochu Caterpillar, Fiat</p> 	DN	závit / thread
	06	DK 06 9/16"-18
	06	DK 06 11/16"-16
	08	DK 08 11/16"-16
	10	DK 10 11/16"-16
	10	DK 10 13/16"-16
	13	DK 13 11/16"-16
	13	DK 13 13/16"-16
	13	DK 13 1"-14
	13	DK 13 1.3/16"-12
	16	DK 16 1"-14
	16	DK 16 1.3/16"-12
	20	DK 20 1"-14
	20	DK 20 1.3/16"-12
	20	DK 20 1.7/16"-12
	25	DK 25 1.7/16"-12
	32	DK 32 1.11/16"-12
40	DK 38 2"-12	

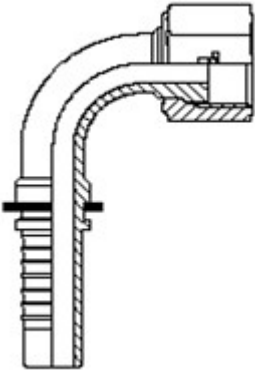
ORFS-DK/90 koncovka tesnenie na plochu Caterpillar, Fiat	DN	závit / thread
	06	DK 06/90 9/16"-18
	06	DK 06/90 11/16"-16
	08	DK 08/90 11/16"-16
	10	DK 10/90 11/16"-16
	10	DK 10/90 13/16"-16
	13	DK 13/90 11/16"-16
	13	DK 13/90 13/16"-16
	13	1DK 13/90 1" -14
	13	DK 13/90 1.3/16"-12
	16	DK 16/90 1" -14
	16	DK 16/90 1.3/16"-12
	20	DK 20/90 1" -14
	20	DK 20/90 1.3/16"-12
	20	DK 20/90 1.7/16"-12
	25	DK 25/90 1.7/16"-12
	25	DK 25/90 1.11/16"-12
	31	DK 32/90 1.11/16"-12
	38	DK 38/90 2"-12

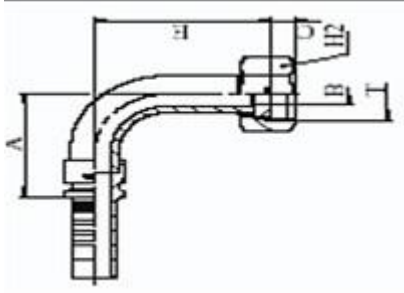
ORFS-DK/90 PREDĽŽENÁ tesnenie na plochu Caterpillar, Fiat	DN	závit / thread
	06	DK 06/90L 9/16"-18
	10	DK 10/90L 11/16"-16
	12	DK 13/90L 13/16"-16
	16	DK 16/90L 1" -14
	19	DK 20/90L 1.3/16"-12
	25	DK 25/90L 1.7/16"-12

ORFS-DK/45 koncovka
 tesnenie na plochu
 Caterpillar, Fiat

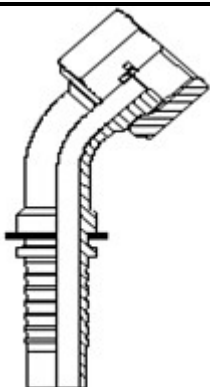

DN	závit / thread
06	DK 06/45 9/16"-18
06	DK 06/45 11/16"-16
08	DK 08/45 11/16"-16
10	DK 10/45 11/16"-16
10	DK 10/45 13/16"-16
13	DK 13/45 13/16"-16
13	DK 13/45 1" -14
13	DK 13/45 1.3/16"-12
16	DK 16/45 1"-14
16	DK 16/45 1.3/16"-12
20	DK 20/45 1" -14
20	DK 20/45 1.3/16"-12
20	DK 20/45 1.7/16"-12
25	DK 25/45 1.7/16"-12
25	DK 25/45 1.11/16"-12
31	DK 32/45 1.11/16"-12
38	DK 38/45 2"-12

JIS-METRICKÝ koncovka 60° vnútorný kužel metrický vnútorný závit norma KOMATSU priama 0°	DN	závit / thread
	06	JIS-K 06 M14x1,5
	08	JIS-K 08 M16x1,6
	10	JIS-K 10 M14x1,5
	10	JIS-K 10 M16x1,4
	10	JIS-K 10 M18x1,5
	12	JIS-K 12 M22x1,5
	12	JIS-K 12 M24x1,5
	16	JIS-K 16 M24x1,5
	19	JIS-K 19 M30x1,5
	25	JIS-K 25 M33x1,5
	32	JIS-K 32 M36x1,5
	40	JIS-K 38 M42x1,5

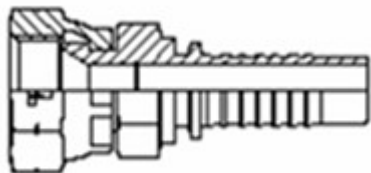

JIS-METRICKÝ koncovka 60° vnútorný kužel metrický vnútorný závit norma KOMATSU uhlová 90°	DN	závit / thread
	06	JIS-K 06-90 M14x1,5
	08	JIS-K 08-90 M16x1,6
	10	JIS-K 10-90 M14x1,5
	10	JIS-K 10-90 M16x1,4
	10	JIS-K 10-90 M18x1,5
	12	JIS-K 12-90 M22x1,5
	12	JIS-K 12-90 M24x1,5
	16	JIS-K 16-90 M24x1,5
	19	JIS-K 19-90 M30x1,5
25	JIS-K 25-90 M33x1,5	

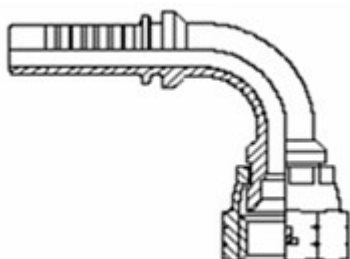

JIS-METRICKÝ koncovka 60° vnútorný kužel metrický vnútorný závit norma KOMATSU uhlová 45°	DN	závit / thread
	06	JIS-K 06-45 M14x1,5
	08	JIS-K 08-45 M16x1,6
	10	JIS-K 10-45 M18x1,5
	12	JIS-K 12-45 M22x1,5
16	JIS-K 16-45 M24x1,5	

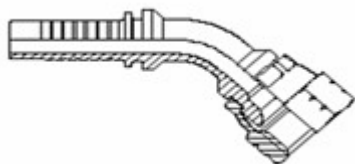

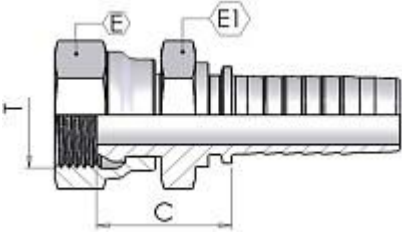
<p>JIS-BSP koncovka vonkajší kužel 60° BSP vnútorný závit norma NISSAN priama 0°</p> 	DN	závit / thread
	06	JIS-N06 1/4"-19
	10	JIS-N10 3/8"-19
	12	JIS-N12 1/2"-14
	16	JIS-N16 3/4"-14
	19	JIS-N20 3/4"-14
	25	JIS-N25 1"-11

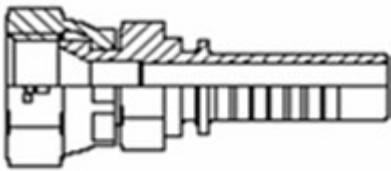
<p>JIS-NISAN koncovka 60° vnútorný kužel BSP vnútorný závit norma TOYOTA priama 0°</p> 	DN	závit / thread
	06	JIS-T06 1/4"-19
	10	JIS-T10 3/8"-19
	12	JIS-T12 1/2"-14
	19	JIS-T20 3/4"-14
	25	JIS-T25 1"-11
	32	JIS-T32 1 1/4"
40	JIS-T40 1 1/2"	

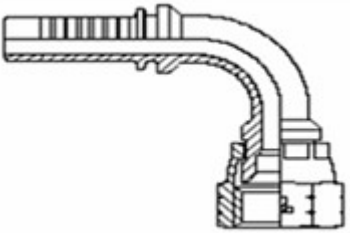
<p>JIS-NISAN koncovka 60° vnútorný kužel BSP vnútorný závit norma TOYOTA uhlova 90°</p> 	DN	závit / thread
	06	JIS-T06-90 1/4"-19
	10	JIS-T10-90 3/8"-19
	12	JIS-T12-90 1/2"-14
	19	JIS-T20-90 3/4"-14
25	JIS-T25-90 1"-11	

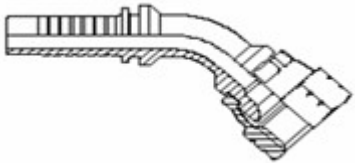
<p>JIS-NISAN koncovka 60° vnútorný kužel BSP vnútorný závit norma TOYOTA uhlova 45°</p> 	DN	závit / thread
	06	JIS-T06-45 1/4"-19
	10	JIS-T10-45 3/8"-19
	12	JIS-T12-45 1/2"-14
	19	JIS-T20-45 3/4"-14
25	JIS-T25-45 1"-11	

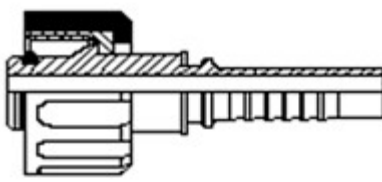
Kärcher starý typ Krátka matica/short nut 	DN	závit / thread
	06	M22x1,5
	08	M22x1,5
	10	M22x1,5
	koncovky sú aj v nerezovom prevedení	

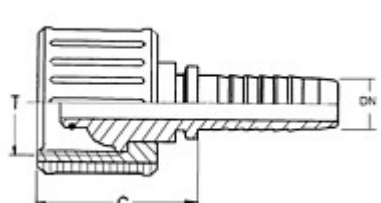
Kärcher nový typ Dlhá matica/long nut 	DN	závit / thread
	06	M22x1,5
	08	M22x1,5
	10	M22x1,5
	koncovky sú aj v nerezovom prevedení	

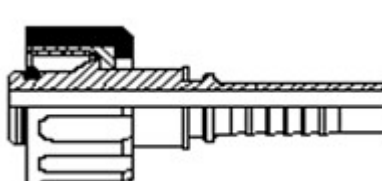
Kärcher starý typ Krátka matica/short nut 	DN	závit / thread
	06	M21x1,5
	08	M21x1,5
	koncovky sú aj v nerezovom prevedení	

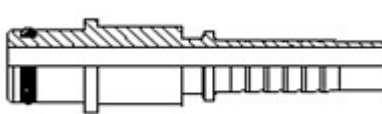
Kärcher pištol /gan nový typ 	DN	
	06	10
	08	10
	koncovky sú aj v nerezovom prevedení	

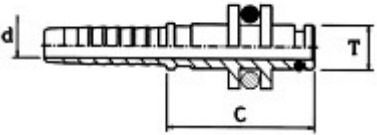
Kärcher pištoľ-ložisko nový typ 	DN	
	06	11
	08	11
	koncovky sú aj v nerezovom prevedení	

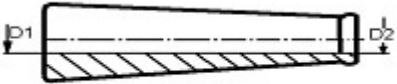
gumený návlek na hadicu 	DN	D1/D2
	black	
	06	14,5/15,0
	08	17/17
	blue	
	06	14,6/14,6
08	17/17	

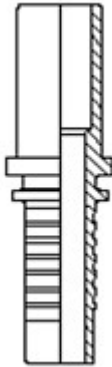
BEL BES 	DN	názov koncovky
	06	BEL/S 6/6
	06	BEL/S 6/8
	06	BEL/S 6/8
	06	BEL/S 6/10
	08	BEL/S 8/10
	08	BEL/S 8/12
	10	BEL/S 10/10
	10	BEL/S 10/12
	10	BEL/S 10/14
	10	BEL 10/15
	12	BES 12/14
	12	BEL 12/15
	12	BES 12/16
	12	BEL 12/18
	16	BEL 16/18
	16	BES 16/20
	16	BEL 16/22
	20	BEL 20/18
	20	BES 20/20
	20	BEL 20/22
	20	BES 20/25
	25	BES 25/25
	25	BEL 25/28
	25	BES 25/30
	32	BES 32/30
	32	BEL 32/35
	32	BES 32/38
	40	BES 40/38
	40	BEL 40/42

BEL
 BES

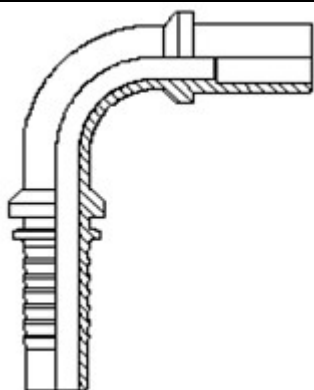

DN	názov koncovky
06	BEL/S 6/6
06	BEL/S 6/8
06	BEL/S 6/10
06	BEL/S 6/12
08	BEL/S 8/10
08	BEL/S 8/12
10	BEL/S 10/10
10	BEL/S 10/12
10	BEL/S 10/14
10	BEL 10/15
12	BES 12/14
12	BEL 12/15
12	BES 12/16
12	BEL 12/18
16	BEL 16/18
16	BES 16/20
16	BEL 16/22
20	BEL 20/18
20	BES 20/20
20	BEL 20/22
20	BES 20/25
25	BES 25/25
25	BEL 25/28
25	BES 25/30
32	BES 32/30
32	BEL 32/35
32	BES 32/38
40	BES 40/38
40	BEL 40/42

BEL
 BES

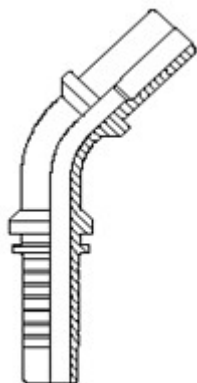

DN	názov koncovky
06	BEL/S 6/6
06	BEL/S 6/8
06	BEL/S 6/10
06	BEL/S 6/12
08	BEL/S 8/10
08	BEL/S 8/12
10	BEL/S 10/10
10	BEL/S 10/12
10	BEL/S 10/14
10	BEL 10/15
12	BES 12/14
12	BEL 12/15
12	BES 12/16
12	BEL 12/18
16	BEL 16/18
16	BES 16/20
16	BEL 16/22
20	BEL 20/18
20	BES 20/20
20	BEL 20/22
20	BES 20/25
25	BES 25/25
25	BEL 25/28
25	BES 25/30
32	BES 32/30
32	BEL 32/35
32	BES 32/38
40	BES 40/38
40	BEL 40/42